



BOSCH

REPAIR PARTS

MODEL PVF

VARIABLE VOLUME VANE TYPE PUMP

FOOT MOUNTED

FLANGED MOUNTED

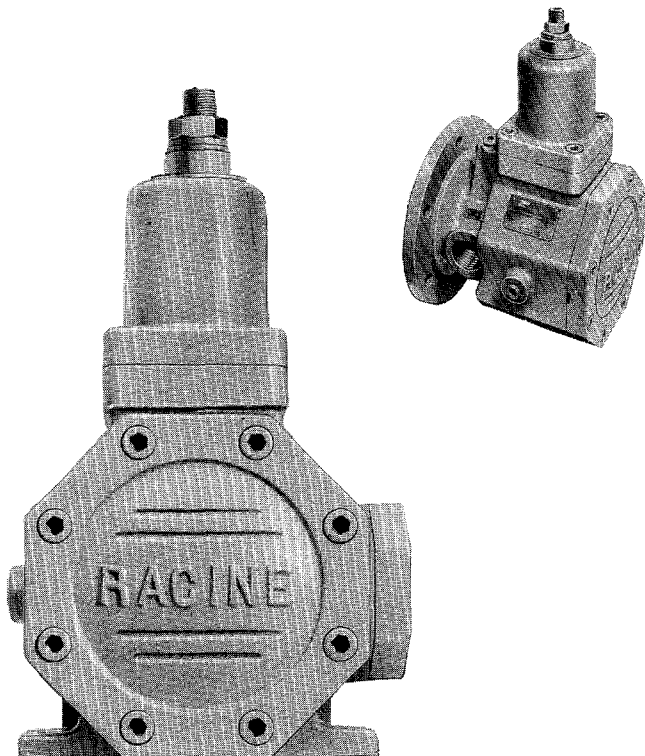

WHEN ORDERING PARTS, FURNISH:

1. COMPLETE CODE NUMBER
2. PARTS REQUIRED
3. SHIPPING INSTRUCTIONS

WRITE FACTORY FOR NEAREST AUTHORIZED
 PARTS AND SERVICE CENTER.

PUMP CODING

PVF - PNT0 - 12ER - 01

- P--PRESSURE COMPENSATOR (STANDARD)
- B--PRESSURE COMPENSATOR (TYPE B)
- C--PRESSURE COMPENSATOR (TYPE C)
- E--HANDWHEEL PRESSURE COMPENSATOR
- H--HYDRAULIC DUAL PRESSURE (INTERNAL)
- J--HYDRAULIC DUAL PRESSURE (EXTERNAL)
- S--SOLENOID-CONTROLLED DUAL PRESSURE
- M--HANDWHEEL VOLUME CONTROL
- L--LEVER VOLUME CONTROL

- N--NO CONTROL
- S--SCREW VOLUME CONTROL
- A--FLANGED MOUNTED
- T--FOOT MOUNTED

- 12--12 GPM
- 20--20 GPM
- 30--30 GPM

- O--ROLLER BEARINGS & BUNA N SEALS
- F--ROLLER BEARINGS & VITON SEALS
- W--JOURNAL BEARINGS (DU) & BUNA N SEALS

- B--250 PSI
- C--500PSI
- E--1000 PSI *

- R--RIGHT HAND ROTATION
- L--LEFT HAND ROTATION
- D--DOUBLE-ENDED SHAFT
- A--COMBINATION SHAFT

* 12 and 20 GPM pumps only.

PVF-PSTO-12**-01

ASSEMBLE WASHER WITH CHAMBER ON I. D. FACING SEAL.

ABOVE STANDARD COMPENSATOR APPEARS ON THIS PAGE. FOR ADDITIONAL COMPENSATORS SEE OPTION PAGE.

SEE OPTION PAGE FOR SCREW VOLUME CONTROL.

B
C
E

SEE MAIN PARTS LISTS FOR AVAILABLE SPRINGS.

20
30

R
L
D

SELECT LETTER BELOW WHICH CORRESPONDS TO THE LETTER APPEARING IN YOUR PUMP CODE.

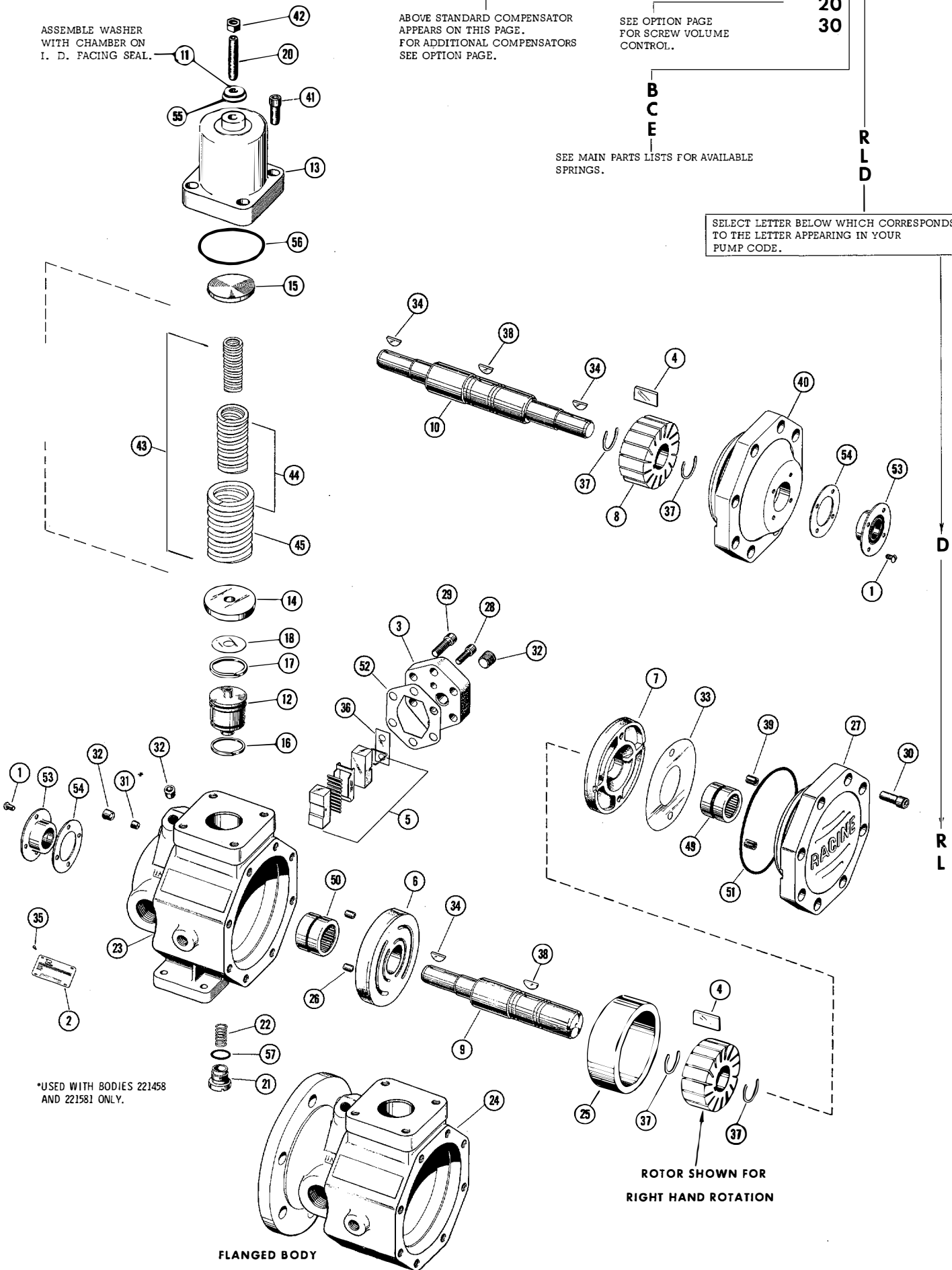

*USED WITH BODIES 221458 AND 221581 ONLY.

ROTOR SHOWN FOR RIGHT HAND ROTATION

FLANGED BODY

Ref. No.	Part No.	Description	Qty.	Ref. No.	Part No.	Description	Qty.
1	404782	Screw 1/4-20 x 3/8	4	25	301131	Ring - 12 GPM (2 FA)	1
2	406780	Nameplate	1	25	301132	Ring - 20 GPM (4 FA)	1
3	220515	Cap	1	25	301133	Ring - 30 GPM (6 FA)	1
4	778270	Vane (Set of 15) 12 GPM	1	26	301142	Pin	2
4	778272	Vane (Set of 15) 20 GPM	1	27	221167	Cover - Use with Journal Bearings RH Rotation	1
4	778273	Vane (Set of 15) 30 GPM	1	27	221608	Cover - Use with Journal Bearings LH Rotation	1
5	777000	Thrust Block	1	27	220523	Cover	1
6	777029	Port Plate RH	1	28	400813	Screw 3/8-16 x 7/8	2
6	777032	Port Plate LH	1	29	400822	Screw 7/16-14 x 1	6
6	777030	Port Plate RH	1	30	400825	Screw 1/2-13 x 1-1/4	8
6	777033	Port Plate LH	1	31	400928	Plug 1/4 N.P.T.F.	1
6	777031	Port Plate RH	1	32	400930	Plug 3/8 N.P.T.F.	2/3
6	777034	Port Plate LH	1	* 33	400591	Shim .001"	As Req'd
7	777089	Cover Plate 12 GPM	1	33	400592	Shim .0015"	As Req'd
7	777090	Cover Plate 20 GPM	1	33	400593	Shim .002"	As Req'd
7	777091	Cover Plate 30 GPM	1	33	400594	Shim .003"	As Req'd
8	302002	Rotor 12 GPM	1	34	401119	Key (2 Required on Double Ended Pump) (Dull Grey)	1
8	302003	Rotor 20 GPM	1	35	401296	Pin	4
8	302004	Rotor 30 GPM	1	* 36	401819	Shim .003"	As Req'd
9	302012	Shaft RH & LH Rotation	1	36	401820	Shim .005"	As Req'd
9	302016	Shaft for Piston Pump Combination (80 Pumps)	1	36	401821	Shim .010"	As Req'd
9	302015	Shaft For Piston Pump (20L)	1	36	405468	Shim .0015"	As Req'd
10	302017	Shaft - Double Ended	1	37	401847	Ring	2
11	491405	Washer	1	38	401871	Key (Blueish Grey)	1
12	220056	Piston	1	39	403308	Pin	2
13	220516	Housing	1	40	221759	Cover-Thru Shaft	1
14	301148	Stop	1	40	222032	Cover - Use with Journal Bearings RH Rotation	1
15	400578	Seat	1	41	400826	Screw 1/2-13 x 1	4
16	401104	Piston Ring	1	42	401015	Nut 5/8-18	1
17	401105	Piston Ring	1	43	401551	Spring	1
* 18	404544	Shim .003"	As Req'd	43	401583	Spring	1
18	404545	Shim .005"	As Req'd	43	401591	Spring	1
20	404908	Screw	1	44	401581	Spring	1
21	302674	Retainer	1	44	401591	Spring	1
22	401524	Spring	1	45	401591	Spring 250 PSI - 12 GPM	1
23	221337	Body (RH Rotation)	1	46	401590	Spring - B	1
23	221386	Body (Use with Journal Bearings RH Rotation)	1	46	405579	Spring - 1000 PSI - 20 GPM	1
23	221341	Body (LH Rotation)	1	46	405578	Spring - 500 PSI - 20 & 30 GPM	1
23	221413	Body (Use with Journal Bearings LH Rotation)	1	46	405580	Spring - 250 PSI - 20 & 30 GPM	1
23	221458	Body (Use with Handwheel and Lever Volume Control RH Rotation)	1	49	405066	Bearing	1
24	221342	Body (RH Rotation)	1	49	777364	Journal Bearing	1
24	221471	Body (Use with Journal Bearings RH Rotation)	1	50	405067	Bearing	1
24	221343	Body (LH Rotation)	1	50	777363	Journal Bearing	1
				51	220528	Cover for Piston Pump (Not Shown)	1
				52	400827	Bolts for Adaptors	8

* Shim Kit 794280 Contains All Shim Stock Qty. 2 Each.

Use Adaptor #220533 for 20 SERIES RADIAL PUMP
Use Adaptor #220534 for 80 SERIES RADIAL PUMP

VITON SEAL KIT 722392

KIT CONSISTS OF -			
Ref. No.	Part No.	Description	Qty.
51	406511	"O" Ring 1/8 x 6 OD	1
52	401842	Gasket	1
53	404321	Seal (2 Required on Double Ended Pumps)	1
54	404322	Gasket	1
55	491404	Thread Seal	1
56	406510	"O" Ring 1/8 x 3-1/2 OD	1
57	406094	"O" Ring 1/8 x 1-1/8 OD	1
—	400579	Gasket	1
—	491405	Thread Seal Washer	1

USED WITH SYNTHETIC FLUIDS (PHOSPHATE ESTER AND HALOGENATED BASE).

REPAIR PARTS KITS*

NEEDLE BEARING KITS

JOURNAL BEARING KITS

	12 GPM	20 GPM	30 GPM	12 GPM	20 GPM	30 GPM
SINGLE SHAFT - RIGHT HAND ROTATION - VITON SEALS-----	NO. 722583	---NO. 722587	---NO. 722591	723361	--- 723369	--- 723375
SINGLE SHAFT - LEFT HAND ROTATION - VITON SEALS-----	NO. 722584	---NO. 722588	---NO. 722592	723362	--- 723368	--- 723376
DOUBLE ENDED SHAFT - VITON SEALS-----	NO. 722755	---NO. 722757	---NO. 722759	723364	--- 723366	--- 723378

* Each kit contains the following parts:
One pressure ring, one set vanes, all shims, one port plate, one cover plate, one cover bearing, one body bearing, one rotor, two piston rings, two snap rings, one thrust block assembly, one shaft, and one seal kit.

OPTIONS

SOLENOID - CONTROLLED DUAL PRESSURE COMPENSATOR

Complete Assembly
 Buna Internal Pilot 956023 VOID
 Buna External Pilot 956022
 Viton Internal Pilot 956053

Ref. No.	Part No.	Description	Qty.
102	405420	Orifice Plug	1
103	220057	Piston (Internal Pilot)	1
103	220059	Piston (External Pilot)	1
104	301147	Stop	1
105	400826	Screw 1/2-13 x 1	4
106	400578	Seat	1
107	405590	Screw 1/2-13 x 1	1
108	*401104	Piston Ring	1
109	401105	Piston Ring	1
110	405578	Spring	1
111	404544	Shim .003"	As Req'd
111	404545	Shim .005"	As Req'd
112	*406510	"O" Ring (Viton)	1
113	220718	Body	1
114	*491 499	Thread Seal Viton	1
115	302310	Seat	1
116	302431	Screw	1
117	304439	Piston	1
118	305873	Poppet	1
119	*400247	Gasket	1
120	*491500	Washer	1
121	400925	Plug 1/16 N P T F	1
122	400928	Plug 1/4 N P T F	2
123	401013	Nut	1
124	*406518	"O" Ring (Viton)	1
125	401485	Spring	1
126	401800	Cover	1
127	402208	Screw #10-32 x 1/2	4
128	405445	Spring	1
129	402663	Base	1
130	Table#1	Solenoid	1
131	Table#1	Coil	1
132	403476	Screw	1
133	304639	Guide	1
134	304640	Retainer	1
135	304641	Pin	1
136	401277	"O" Ring 3/32 x 11/16 OD	1
136	*406478	"O" Ring (Viton)	1
137	*406092	Seal (Viton)	1
138	403057	Screw	2

*Items In Seal Kit 723662

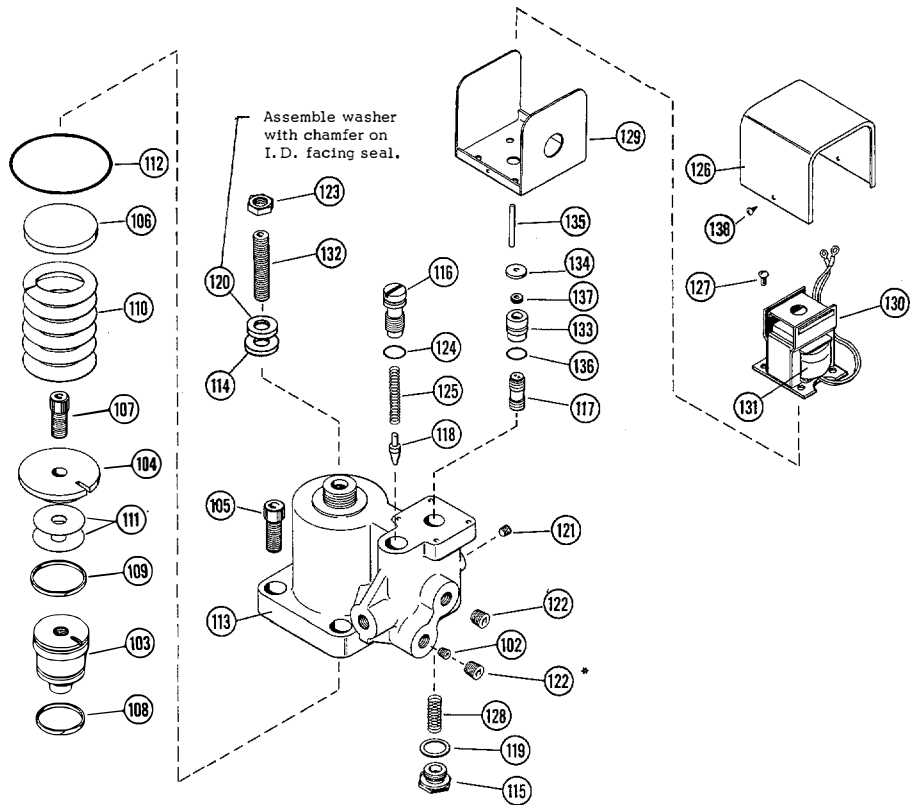

NOTE: ORIFICE PLUG #405420 (REFERENCE #102) USED ONLY WITH EXTERNAL PILOT.

* REMOVE FOR EXTERNAL PILOT.

DC SOLENOIDS		
Complete Solenoid (130)	Coil Only (131)	DC Voltage
403233	—	12
402570	—	24
403006	—	125
402448	403479	250

AC SOLENOIDS		
Complete Solenoid (130)	Coil Only (131)	AC Voltage
400991	401662	115/60
400992	401663	230/60
400993	401664	440/60
403158	403772	115/50
402953	403975	220/50
406030	404711	440/50

SCREW VOLUME CONTROL

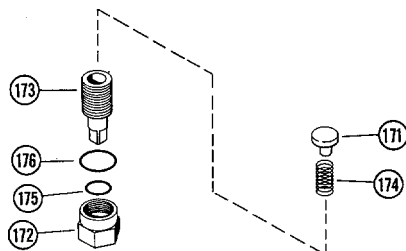

Assembly Numbers
 Viton 721999

Ref. No.	Part No.	Description	Qty.
171	301173	Button	1
172	301175	Nut	1
173	301176	Stem	1
174	401524	Spring	1
175	406584	"O" Ring 3/32 x 13/16 OD	1
176	406802	"O" Ring 1/8 x 1-5/16 OD	1

OPTIONS

HYDRAULIC DUAL PRESSURE COMPENSATOR

Complete Assembly
 Buna Internal Pilot 956021 VOID
 Viton Internal Pilot 956045 VOID
 Buna External Pilot 956020 VOID
 Viton External Pilot 956046

Ref. No.	Part No.	Description	Qty.
78	220057	Piston (Use with Internal Pilot)	1
78	220059	Piston (Use with External Pilot)	1
80	301147	Stop (Use with Internal Pilot)	1
80	301148	Stop (Use with External Pilot)	1
82	405590	Screw 1/2-13 x 1	1
* 83	401104	Piston Ring	1
* 84	401105	Piston Ring	1
85	404544	Shim .003"	As Req'd
85	404545	Shim .005"	As Req'd
86	405578	Spring	1
87	220031	Body	1
* 88	491499	Thread Seal	1
89	301161	Cap	1
90	401013	Nut	1
91	305873	Poppet	1
92	305963	Screw	1
93	400578	Seat	1
* 94	491500	Washer	1
95	400825	Screw 1/2-13 x 1	4
96	401013	Nut	1
* 97	401083	Gasket	2
* 98	406510	"O" Ring (Viton)	1
99	401489	Spring	1
100	403476	Screw	1
101	405420	Orifice Plug	1

* In Viton Seal Kit: 723663

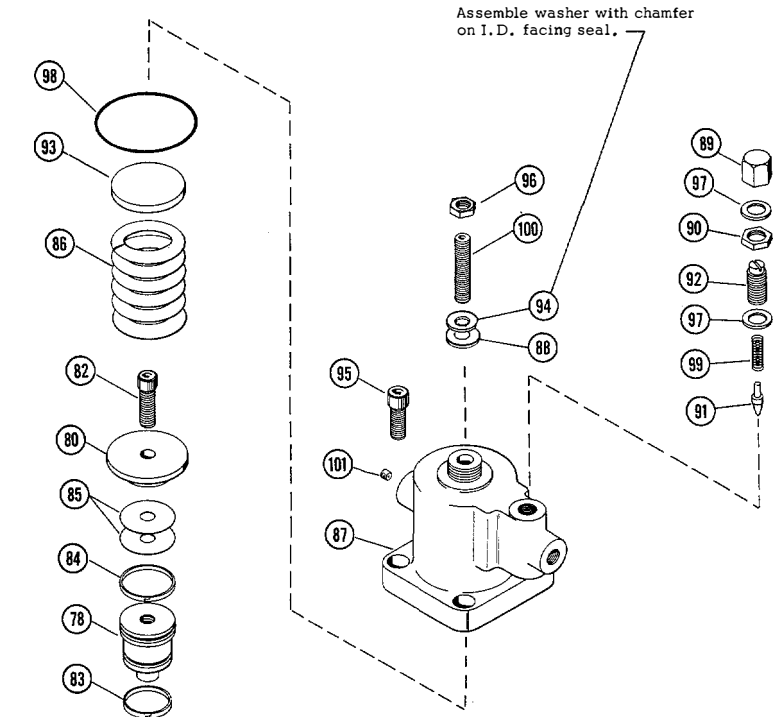

NOTE: ORIFICE PLUG #405420 (REFERENCE #101) USED ONLY WITH EXTERNAL PILOT.

HANDWHEEL VOLUME CONTROL

USE RELIEF VALVE
 WITH THIS OPTION

**VOID PRODUCT
 NOT ALL PARTS AVAILABLE**

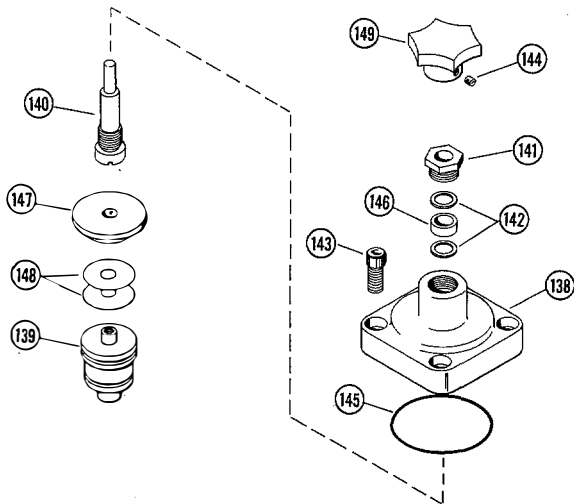

*NOTE: USE RING HOLD-UP SPRING #401512 WITH THIS OPTION (SIMILAR TO REFERENCE #22, PAGE 2). ALSO REFER TO REFERENCE NO. 23 FOR SPECIAL BODY THAT IS REQUIRED.

Complete Assembly
 Viton 956048

Ref. No.	Part No.	Description	Qty.
138	220038	Cap	1
139	220056	Piston	1
140	301098	Stem	1
141	301099	Nut	1
142	301171	Washer	2
143	400825	Screw 1/2-13 x 1-1/4	4
144	400854	Screw 1/4 x 3/8	1
145	406510	"O" Ring (Viton)	1
146	406479	Seal (Viton)	2
147	301145	Stop	1
148	404544	Shim .003"	As Req'd
148	404545	Shim .005"	As Req'd
149	404784	Handwheel	1

OPTIONS

HANDWHEEL PRESSURE COMPENSATOR

Complete Assembly
Buna 956049

Ref. No.	Part No.	Description	Qty.
58	404784	Hand Wheel	1
59	220056	Piston	1
60	220516	Housing	1
61	301148	Stop	1
62	401015	Nut	1
63	491405	Washer-Thread Seal	1
64	308600	Stem	1
65	491372	Washer-Thread Seal	1
66	400578	Seat	1
67	400854	Screw, 1/4 X 3/8	1
68	400826	Screw 1/2 - 13 X 1	4
69	401281	"O" Ring, 1/8 X 3 1/2 OD (Buna)	1
70	401104	Piston Ring	1
71	401105	Piston Ring	1
72	See Main Parts List	Springs	3/1
73	404544	Shim .003"	As Req'd
73	404545	Shim .005"	As Req'd

*SEE MAIN PARTS LIST FOR AVAILABLE SPRINGS

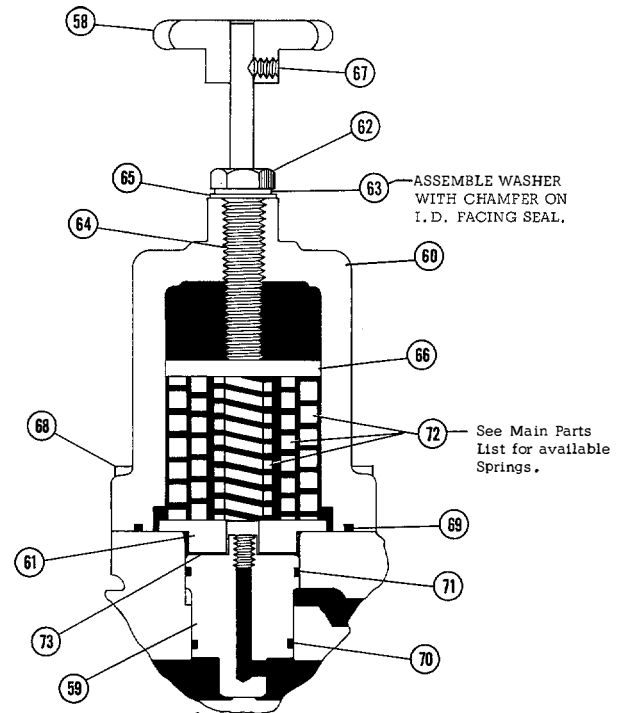

**VOID PRODUCT
NOT ALL PARTS AVAILABLE**

* LEVER VOLUME CONTROL

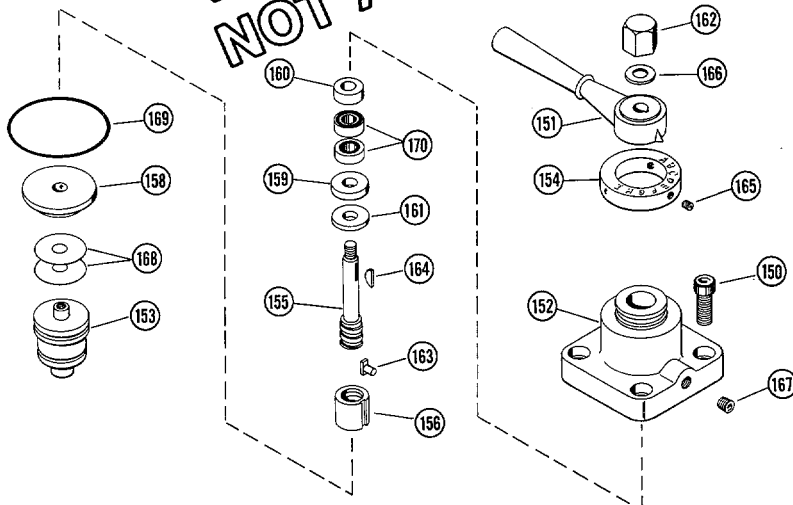

NOTE: USE RELIEF VALVE WITH THIS OPTION

Ref. No.	Part No.	Description	Qty.
150	400825	Screw 1/2-13 x 1-1/4	4
151	220037	Lever	1
152	220040	Body	1
153	220056	Piston	1
154	275071	Collar	1
155	301096	Stem	1
156	301097	Nut	1
158	301145	Stop	1
159	301357	Washer	1
160	301358	Washer	1
161	301959	Washer	1
162	301969	Nut	1
163	301971	Key	1
164	306088	Key	1
165	400853	Set Screw	3
166	400909	Washer	1
167	400922	Plug	1
168	404544	Shim .003"	As Req'd
168	404545	Shim .005"	As Req'd
169	406510	"O" Ring (Viton)	1
170	400668	Seal	2

* NOTE: USE RING HOLD-UP SPRING #401512 WITH THIS OPTION (SIMILAR TO REFERENCE #22, PAGE 2). ALSO REFER TO REFERENCE NO. 23 FOR SPECIAL BODY THAT IS REQUIRED.

9 535 233 255

ATUS RSB 003/29 (8.93)

ROBERT BOSCH FLUID POWER CORPORATION
P.O. BOX 2025
RACINE, WISCONSIN 53401-2025 U.S.A.
Phone (414)554-7100, Fax (414)554-7117

Printed in USA



BOSCH